

Ecobox®

Ecobox®

江西益扣科技集团有限公司
Jiangxi ECO technology Group Co.,Ltd

PROFESSIONAL /QUALITY /INNOVATIVE /DIRECT
SELLING /ATTRACTIVE /2023



官方二维码
Company Wechat

了解更多信息,请联系我们 Contact us

地址:江西省南昌市南昌县小蓝经济开发区金沙二路1533号
(ADD):No.1533,Jinsha 2nd Road,Xiaolan Economic Development Zone,Nanchang County,Nanchang City,Jiangxi Province

网址: www.jxecobox.com

邮箱: info@jxecobox.com
(EMAIL)

电话: 0791-87684368
(TEL)

WEB: www.jxecobox.com



**IMPROVE SHOPPING
EXPERIENCE**

提升商超形象 改善购物体验

COMPANY

公司简介 PROFILE

益扣集团(全称江西益扣科技集团有限公司),其前身是南昌市仁创展柜有限公司,益扣2015年成立于中国南昌,是专注于食品储存和陈列展示容器的集团性公司。

自创立以来,益扣矢志以超高的品质和尽心的服务服务于食品储陈行业,为食品公司和消费大众做好日常食品的保驾护航当好食品安全卫士。秉承“勤劳,诚信,学习,创新”的核心价值观,坚持走独立自主,应用研发,开放包容的战略路线。经过十余年的发展,益扣集团已在中国多省市以及欧美国家和中东地区建立供货中心和商务机构。并以公司技术中心为基础,联手南昌大学,东华理工大学,华润化学等积极技术攻关和产品创新。益扣产品得到全球知名食品企业的认可和选用,同时也越来越多的走进大众消费者日常生活。包括李雷与韩梅梅,甲壳虫,瑞利来,一扫光,盐津铺子,三只松鼠,马大姐,赵一鸣等,为其提供全方位OEM配套服务和食品储陈全套解决方案。并被各大食品企业评为优质供应商。益扣集团是“工业4.0”的积极探索者和实践者。公司以科技引领发展,以创新为驱动,通过智能制造,为客户提供一个有灵魂的食品容器。其信息技术与自动化生产位居国内行业前列。

益扣前卫的思想,成熟的技术正引领国内行业进一步的发展,并且服务于全球食品公司和普通大众消费群体

JIANGXI ECO TECHNOLOGY GROUP CO., LTD, was adhering the development of Nanchang Renchuang Showcase Co., Ltd, established in Nanchang, China in 2015. It is a group company focusing on food storage and display solution.

Since its establishment, Ecobox has been committed to serving the food storage industry with super high quality and dedicated service, escort daily food for food companies and consumers and be a good food safety guard. Adhering to the core values of "hard work, integrity, learning, and innovation", we adhere to the strategic route of independence, application research and development, and openness and tolerance. After more than ten years of development, Ecobox Group has established supply centers and business organizations in many provinces and cities in China, European and American countries and the Middle East. And based on the company's technology center, it has joined hands with Nanchang University, East China University of Technology, China Resources Chemical and other active technological breakthroughs and product innovation. Ecobox products have been recognized and selected by world-renowned food companies, and more and more have entered the daily life of mass consumers, providing them with a full range of OEM supporting services and a complete set of food storage solutions. It has been rated as a high-quality supplier by major food companies. Ecobox Group is an active explorer and practitioner of "Industry 4.0". The company leads the development with science and technology, is driven by innovation, and provides customers with a soulful food container through intelligent manufacturing. Its information technology and automated production are in the forefront of the domestic industry.

Ecobox's avant-garde thinking and mature technology are leading the further development of the domestic industry, and serving global food companies and general public consumer groups.

CATALOGUE

目录

公司简介	Company Profile	P01
文化体系	Corporate Culture	P02-P03
发展历程	Development History	P04-P05
企业理念	Corporate Philosophy	P06-P08
产品展示	Product Display	P9-P60
技术资源	Technical Resources	P61-P62
生产设备	Production Equipment	P63-P64



ENTERPRISE POSITIONING | 企业定位

益扣集团是一家专业从事商超食品陈列容器和展示道具的公司, 具备塑胶陈列用品的开发制造能力, 擅长透明塑胶用品的开发制造。

Ecobox Group is a company specializing in supermarket food display containers and display props. It has the development and manufacturing capabilities of plastic display products, and is good at the development and manufacture of transparent plastic products. In the future, it may enter the supermarket intelligent equipment software system and retail business management industry.

行业定位 location

食品储陈 = 储藏 + 陈列
store display

BRAND POSITIONING 品牌定位



Ecobox

ECO的本意为环保的, 是指一种节能模式, 这一名称又由Ecology (生态)、Conservation (节能) 和 Optimization (优化) 合成而得。现常见的一种技术就是汽车行业ECO模式 (节能环保模式)。ECO从诞生开始, 就以技术, 环保和经济性为设计研发基本理念。BOX本意就是盒子, 箱子。所以Ecobox品牌自诞生开始, 益扣集团就以节能环保的陈列容器来定位发展路线, 并且把ECO的直接音译“益扣”作为品牌中文名称。Ecobox品牌的标识通过简单字体设计并冠以整体草绿色的形式呈现, 直接明了的体现了益扣品牌对于环保的定位, 益扣品牌对于环保的追求, 这也将是整个益扣集团企业文化的重要组成部分。



D DEVELOPMENT HISTORY

发展历程

2012

紧随潮流大势，积极布局电商零售在淘宝、天猫、阿里巴巴等电商平台开立店铺，构建线上销售体系。

In 2012, follow the trend, actively deploy e-commerce retail, open stores on Taobao, Tmall, Alibaba and other e-commerce platforms, and build an online sales system.

2007

成立“仁创展柜公司”，着手研发铝合金展柜产品，同时尝试制作终端亚克力食品陈列盒及塑料制品。

In 2007, set up "Nanchang Renchuang Showcase Co., Ltd.", started to research and develop aluminum alloy showcase products, and tried to produce terminal acrylic food bins and plastic products.

2014

公司创始人赴美调研，回国后自主研发国内第一款“重力盒”产品。

In 2014, the founder of our company went to the United States for research, and independently developed the first "gravity bin" in China after returning to China.

2015

为了打破行业现状，彻底提高裸装食品陈列品质，公司重新布局，成立江西省益扣实业有限公司。

In 2015, in order to break the industry status quo and thoroughly improve the display quality of naked food "Jiangxi ECO Industrial Co., LTD." came into being.

2016

公司正式成立“外贸部”，主要负责公司产品在国外市场的销售至此益扣实业成为国内唯一一家面向全球专业生产、销售商超食品陈列容器的公司。

In 2016, set up "Foreign Trade Department", becoming the only domestic company specializing in the global production and sales of super food display containers the founder of the enterprise went to Europe for market research.

2017

“南昌市仁创展柜有限公司”成立 10 周年，公司首次赴海外（德国）参加“全球商超设备展”

In 2017, the 10th anniversary of the establishment of "Nanchang Renchuang Showcase Co., Ltd.", our company went overseas (Germany) for the first time to participate in the "EUROSHOP 2017"

2020

公司第二次赴德国参加“EUROSHOP 展会”并签下 300 万大单的好成绩。

In 2020, went to Germany for the second time to participate in the "EUROSHOP2020".

2021

全资收购拥有 21 年发展历程的江西融德防伪科技有限公司，自此，公司拥有自有厂房和土地 75 亩。

In 2021, Wholly-owned acquisition of Jiangxi Rongde Anti-Counterfeiting Technology Co., Ltd., which has a development history of "21" years.

O OUR
VALUES
我们的价值观

// 核心价值观
CORE VALUE

尊重自然, 和谐发展:益扣锚定双碳目标, 产品研发, 生产制造, 市场服务过程中坚持绿色、环保、低碳的理念, 加强绿色低碳技术的创新与应用, 做到整个过程零填埋、零污染、零浪费。尊重自然的发展规律, 与大自然环境和谐发展。

Zerowaste concept, respect the law of natural development and develop harmoniously with the natural environment.

天地人和, 上下同欲:益扣对外奉行共生双赢、和谐发展, 对内倡导员工与企业心手相牵、荣辱与共, 使企业成为坚不可摧的金刚石组织。

Ecobox pursues symbiotic win-win and harmonious development externally, and internally advocates that employees and enterprises are hand in hand and share weal and woe.



OUR
VALUES

求真求善, 换位思考:益扣管理人员设身处地忧员工之忧, 明员工之困, 查员工之情, 以员工的角度看待问题, 解决问题, 追求员工之真, 员工之善, 员工之美。使员工持续愿意并且乐意为企业长远发展而努力奋斗。

Do every efforts to make employees continue to be willing and willing to work hard for the long-term development of the company.

积极学习, 天天向上:益扣鼓励员工学习先进的思想, 借鉴好的经验, 接受新的科学技术和先进管理理念, 大家积极互相持续学习, 共同进步, 不断超越。

Keep studying to make self-improvement, accepting new science and technology and management concepts

CORPORATE CULTURE | 企业文化

FOCUSING ON SERVING FMCG PRODUCTS, INTEGRITY, DEDICATION,
PRAGMATISM, INNOVATION, INTERNATIONALIZATION, BRANDING,
SPECIALIZATION, ACHIEVING CUSTOMERS, BRANDS AND EMPLOYEES



愿景

以超高的品质和尽心的服务打造一流的品牌
成为全球裸装食品陈列行业的领路者。

Create a first-class brand with high quality and dedicated
service to become the leader of the global bulk food display
industry.

使命

提升商超形象，改善购物体验。

Improve shopping experience

ZT SERIES GRAVITY BINS

重力盒系列

食品级进口材料，通过欧盟检测不含BPA
上进下出的设计可保持食物新鲜

Food grade raw material, compliant with FDA Approved and
BPA Free under EU0/2011 regulation.



*部分适用食品展示

Features:

糖果类* Candies



彩虹糖 巧克力豆 棉花糖 硬糖 奶片 m豆 石头糖

粗粮类* Grains



大米 小米 黑米 荞麦 莲子 红豆 绿豆 黑豆



黄豆

坚果类* Nuts



开心果 杏仁 腰果 松子 夏威夷果 白果 南瓜子 西瓜子



葵花籽

宠物粮食类* Pet food



常规猫粮 冻干猫粮 常规狗粮 鱼食

LEGUMBRES

PASTAS

SEEDS

GRANOLA

Zero Waste



Z **ZT SERIES**
GRAVITY BINS
重力盒系列

产品编号 (Item No.) ZT-01	
产品尺寸 (Product size) 350*154*710	
容量 (Capacity) 19L	
材质 (The material) PCTG/PC	
容纳食材: 彩虹糖 ≈ 16.5kg、大米 ≈ 30kg、开心果 ≈ 12kg、猫粮 ≈ 9.5kg Food ref: Skittles 16.5kg, Rice 30kg, Pistachios 12kg, Cat Food 9.5kg	



产品编号 (Item No.) ZT-02	
产品尺寸 (Product size) 350*154*570	
容量 (Capacity) 13L	
材质 (The material) PCTG/PC	
容纳食材: 彩虹糖 ≈ 11kg、大米 ≈ 22kg、开心果 ≈ 8.4kg、猫粮 ≈ 6.5kg Food ref: Skittles 11kg, Rice 22kg, Pistachios 8.4kg, Cat Food 6.5kg	



Z **ZT SERIES**
GRAVITY BINS
重力盒系列

产品编号 (Item No.) ZT-03	
产品尺寸 (Product size) 350*154*435	
容量 (Capacity) 8L	
材质 (The material) PCTG/PC	
容纳食材: 彩虹糖 ≈ 7kg、大米 ≈ 13kg、开心果 ≈ 5kg、猫粮 ≈ 4kg Food ref: Skittles 7kg, Rice 13kg, Pistachios 5kg, Cat Food 4kg	



产品编号 (Item No.) ZT-04	
产品尺寸 (Product size) 350*100*460	
容量 (Capacity) 6L	
材质 (The material) PCTG/PC	
容纳食材: 彩虹糖 ≈ 5kg、大米 ≈ 10kg、开心果 ≈ 4kg、猫粮 ≈ 3kg Food ref: Skittles 5kg, Rice 10kg, Pistachios 4kg, Cat Food 3kg	



Z **ZT SERIES**
GRAVITY BINS
重力盒系列

产品编号 (Item No.) ZT-05	
产品尺寸 (Product size) 350*100*570	
容量 (Capacity) 10L	
材质 (The material) PCTG/PC	
容纳食材: 彩虹糖 ≈ 9kg、大米 ≈ 17kg、开心果 ≈ 6.5kg、猫粮 ≈ 5kg Food ref: Skittles 9kg, Rice 17kg, Pistachios 6.5kg, Cat Food 5kg	



产品编号 (Item No.) ZT-06	
产品尺寸 (Product size) 350*100*710	
容量 (Capacity) 13L	
材质 (The material) PCTG/PC	
容纳食材: 彩虹糖 ≈ 11kg、大米 ≈ 22kg、开心果 ≈ 8kg、猫粮 ≈ 6.5kg Food ref: Skittles 11kg, Rice 22kg, Pistachios 8kg, Cat Food 6.5kg	



Z **ZT SERIES**
GRAVITY BINS
重力盒系列

产品编号 (Item No.) ZT-07	
产品尺寸 (Product size) 355*152*675	
容量 (Capacity) 19L	
材质 (The material) PCTG/PC/PET	
容纳食材: 彩虹糖 ≈ 16.5kg、大米 ≈ 30kg、开心果 ≈ 12kg、猫粮 ≈ 9.5kg Food ref: Skittles 16.5kg, Rice 30kg, Pistachios 12kg, Cat Food 9.5kg	



产品编号 (Item No.) ZT-08	
产品尺寸 (Product size) 355*152*525	
容量 (Capacity) 13L	
材质 (The material) PCTG/PC/PET	
容纳食材: 彩虹糖 ≈ 11kg、大米 ≈ 22kg、开心果 ≈ 8kg、猫粮 ≈ 6.5kg Food ref: Skittles 11kg, Rice 22kg, Pistachios 8kg, Cat Food 6.5kg	



Z **ZT SERIES**
GRAVITY BINS
重力盒系列

产品编号 (Item No.) ZT-09	
产品尺寸 (Product size) 355*102*675	
容量 (Capacity) 10L	
材质 (The material) PCTG/PC/PET	
容纳食材: 彩虹糖 ≈ 9kg、大米 ≈ 17kg、开心果 ≈ 6.5kg、猫粮 ≈ 5kg Food ref: Skittles 9kg, Rice 17kg, Pistachios 6.5kg, Cat Food 5kg	



产品编号 (Item No.) ZT-10	
产品尺寸 (Product size) 355*100*525	
容量 (Capacity) 8L	
材质 (The material) PCTG/PC/PET	
容纳食材: 彩虹糖 ≈ 7kg、大米 ≈ 13kg、开心果 ≈ 5kg、猫粮 ≈ 4kg Food ref: Skittles 7kg, Rice 13kg, Pistachios 5kg, Cat Food 4kg	



Z **ZT SERIES**
GRAVITY BINS
重力盒系列

产品编号 (Item No.) FZ-27	
产品尺寸 (Product size) 215*144*102	
产品编号 (Item No.) FZ-28	
产品尺寸 (Product size) 148*268*29°	

产品编号 (Item No.) MO-001	
竹制底座 Bamboo base	
产品编号 (Item No.) TG-05	
小铁柜 Iron Base	

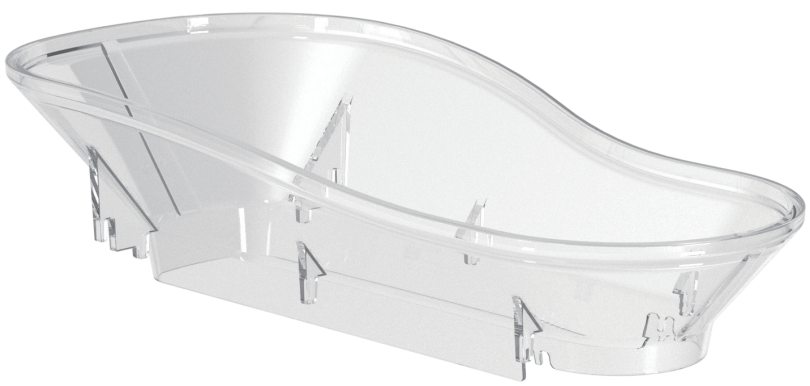
产品编号 (Item No.) FZ-62	
产品尺寸 (Product size) 411*208*105	
容量 (Capacity) -	
材质 (The material) PC/PETG	

LD SERIES FOOD BINS

流动式储存盒系列

食品级进口材料，通过欧盟检测不含BPA
上进下出的设计可保持食物新鲜

Food grade raw material, compliant with FDA Approved and
BPA Free under EU0/2011 regulation.

*部分适用食品展示

Features:

粗粮类* Grains



糖果类* Candies



坚果类* Nuts



干果类* Dry fruits



store above and sell below



LD SERIES
FOOD BINS
流动式储藏盒系列

产品编号 (Item No.) LD-01	
产品尺寸 (Product size) 295*420*345	
容量 (Capacity) 24L	
材质 (The material) PCTG/PC/PET	
容纳食材: 开心果≈16kg、小麦≈19kg、葵花籽≈17kg、棉花糖≈21kg Food ref: Pistachios 16kg, Wheat 19kg, Sunflower Seeds 17kg Cotton Candy 21kg	



产品编号 (Item No.) LD-02	
产品尺寸 (Product size) 200*400*330	
容量 (Capacity) 12L	
材质 (The material) PCTG/PC/PET	
容纳食材: 开心果≈8kg、小麦≈9kg、葵花籽≈9kg、棉花糖≈10kg Food ref: Pistachios 8kg, Wheat 9kg, Sunflower Seeds 9kg Cotton Candy 10kg	



LD SERIES
FOOD BINS
流动式储藏盒系列

产品编号 (Item No.) LD-03	
产品尺寸 (Product size) 222*315*350	
容量 (Capacity) 10L	
材质 (The material) PCTG	
容纳食材: 开心果≈7kg、小麦≈8kg、葵花籽≈7kg、棉花糖≈9kg Food ref: Pistachios 7kg, Wheat 8kg, Sunflower Seeds kg Cotton Candy 9kg	



产品编号 (Item No.) LD-04	
产品尺寸 (Product size) 340*260*150	
容量 (Capacity) 8L	
材质 (The material) PP+PC	
容纳食材: 巧克力豆≈7kg、葵花籽≈6kg、小麦≈6kg、开心果≈5kg Food ref: Pistachios 7kg, Wheat 6kg, Sunflower Seeds 6kg Cotton Candy 5kg	

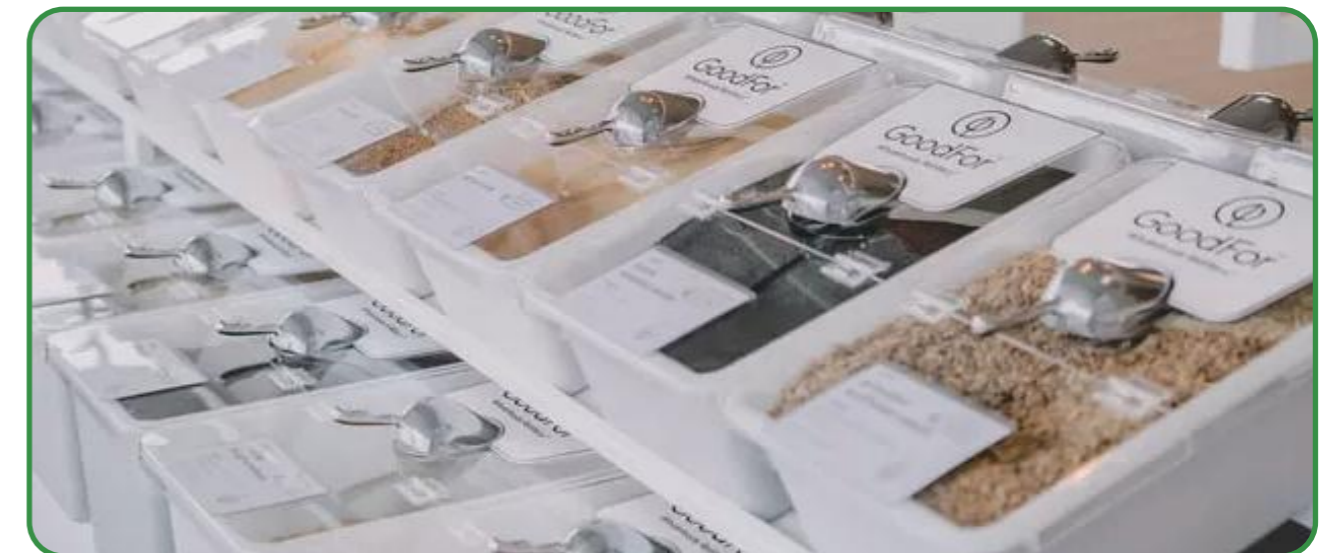

LD SERIES
FOOD BINS
流动式储藏盒系列

产品编号 (Item No.) LD-05	
产品尺寸 (Product size) 440*350*190	
容量 (Capacity) 15L	
材质 (The material) PP+PC	
容纳食材: 巧克力豆 ≈ 13kg、葵花籽 ≈ 11kg、小麦 ≈ 12kg、开心果 ≈ 10kg Food ref: Chocolate Beans 13kg, Sunflower Seeds 11kg, Wheat 12kg, Pistachios 10kg	



M SERIES FOOD BINS

密封陈列盒系列

食品级材料，容量大、密封性能强

Food grade material, big capacity and good airtight function.



*部分适用食品展示

Features:

药材类*

Medical materials



话梅干果类*

Dry fruits



坚果类*

Nuts



糖果类*

Candies



粗粮类*

Grains



Ecobox

**SEALED
BINS
DISPLAY
IN
STORES**



M **M SERIES**
FOOD BINS
密封陈列盒系列

产品编号 (Item No.) MF-01	
产品尺寸 (Product size) 200*180*200	
容量 (Capacity) 6L	
材质 (The material) PC	
容纳食材: 荞麦 ≈ 10kg、葵花籽 ≈ 9kg、开心果 ≈ 4kg、棉花糖 ≈ 5kg Food ref: Buckwheat 10kg, Sunflower Seeds 9kg, Pistachios 4kg, Cotton Candy 5kg	

产品编号 (Item No.) MF-02/15	
产品尺寸 (Product size) 300*300*200 300*300*150	
容量 (Capacity) 11L/8L	
材质 (The material) PET/PC	
容纳食材: 荞麦 ≈ 18kg、葵花籽 ≈ 16kg、开心果 ≈ 7kg、棉花糖 ≈ 10kg Food ref: Buckwheat 18kg, Sunflower Seeds 16kg, Pistachios 7kg, Cotton Candy 10kg	



M **M SERIES**
FOOD BINS
密封陈列盒系列

产品编号 (Item No.) MF-03/16	
产品尺寸 (Product size) 300*400*200 300*400*150	
容量 (Capacity) 17L/12L	
材质 (The material) PET/PC	
容纳食材: 荞麦 ≈ 28kg、葵花籽 ≈ 25kg、开心果 ≈ 11kg、棉花糖 ≈ 15kg Food ref: Buckwheat 28kg, Sunflower Seeds 25kg, Pistachios 11kg Cotton Candy 15kg	



产品编号 (Item No.) MF-04	
产品尺寸 (Product size) 140*140*220	
容量 (Capacity) 3L	
材质 (The material) PCTG/PC	
容纳食材: 人参 ≈ 2kg、鱼胶 ≈ 1kg、冬虫夏草 ≈ 5kg、鹿茸 ≈ 5kg Food ref: Ginseng 2kg, Isinglass 1kg, Cordyceps 5kg, Antler 5kg	



M **M SERIES**
FOOD BINS
密封陈列盒系列

产品编号 (Item No.) MF-05/06/07/08		
	产品尺寸 (Product size) 200*200*200	产品尺寸 (Product size) 250*250*250
容量 (Capacity) 7L/13L/8L/13L		
材质 (The material) PC	产品尺寸 (Product size) 200*250*200	产品尺寸 (Product size) 250*300*200
容纳食材: 人参≈9kg、鱼胶≈4kg、冬虫夏草≈24kg、鹿茸≈21kg Food ref: Ginseng 9kg, Isinglass 4kg, Cordyceps 24kg, Antler 21kg		



产品编号 (Item No.) MY-01	
产品尺寸 (Product size) 170*160*222	
容量 (Capacity) 5L	
材质 (The material) PC	
容纳食材: 彩虹糖≈5kg、葵花籽≈7kg、棉花糖≈4kg、荞麦≈8kg Food ref: Skittles 5kg, Sunflower Seeds 7kg, Cotton Candy 4kg, Buckwheat 8kg	

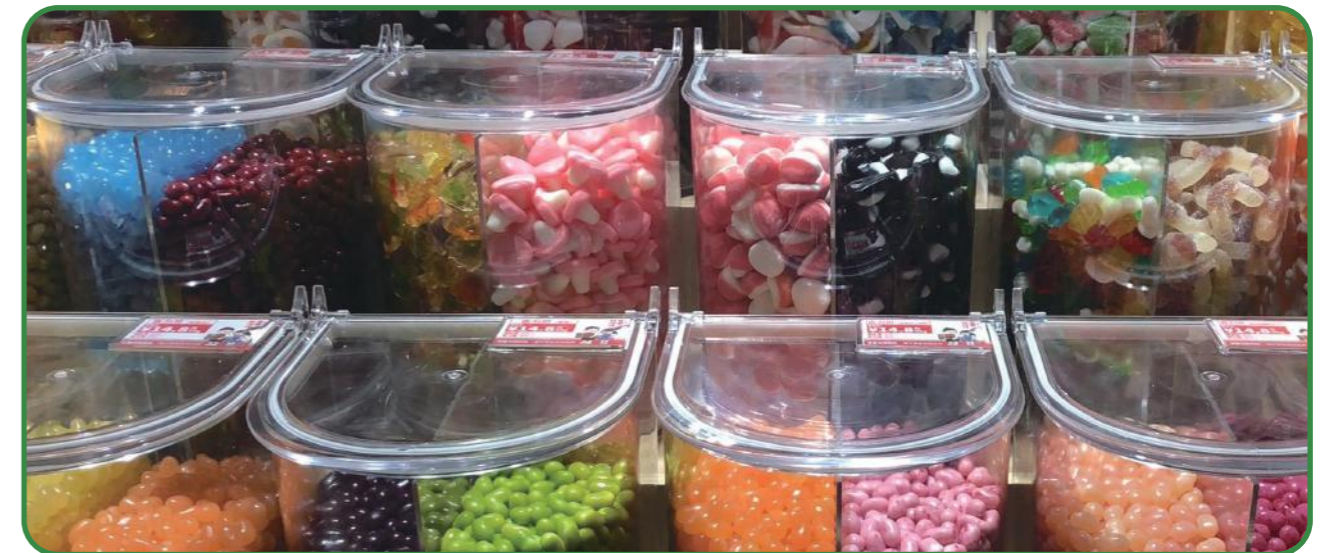

M **M SERIES**
FOOD BINS
密封陈列盒系列

产品编号 (Item No.) MY-02/03	
产品尺寸 (Product size) φ250*250 φ250*350	
容量 (Capacity) 10L/14L	
材质 (The material) PC/PET	
容纳食材: 彩虹糖 ≈ 7kg、棉花糖 ≈ 12kg、葵花籽 ≈ 20kg、花生 ≈ 20kg Food ref: Skittles 7kg, Cotton Candy 12kg, Sunflower Seeds 20kg, Peanuts 20kg	



产品编号 (Item No.) MY-0601/02/03	 <p>透明盖 竹制盖</p>
φ120	 <p>φ120*100 φ120*200 φ120*300</p>
容量 (Capacity) 1L/2L/3L	
材质 (The material) PC	
容纳食材: 人参 ≈ 2kg、鱼胶 ≈ 1kg、冬虫夏草 ≈ 5kg、鹿茸 ≈ 5kg Food ref: Ginseng 2kg, Isinglass 1kg, Cordyceps 5kg, Antler 5kg	



M **M SERIES**
FOOD BINS
密封陈列盒系列

产品编号 (Item No.) MY-0801/02/03	 透明盖	 竹制盖	
φ150			
容量 (Capacity) 1L/4L/3L	φ150*100	φ150*200	φ150*300
材质 (The material) PC/PET			
容纳食材:彩虹糖≈3kg、葵花籽≈4kg、人参≈2kg、冬虫夏草≈5kg Food ref: Skittles 3kg, Sunflower Seeds 4kg, Ginseng 2kg, Cordyceps 5kg			



产品编号 (Item No.) MY-0401/02/03	 透明盖	 竹制盖	
φ200			
容量 (Capacity) 2L/5L/8L	φ200*100	φ200*200	φ200*300
材质 (The material) PC			
容纳食材:人参≈6kg、鱼胶≈3kg、冬虫夏草≈15kg、鹿茸≈13kg Food ref: Ginseng 6kg, Isinglass 3kg, Cordyceps 15kg, Antler 13kg			



M **M SERIES**
FOOD BINS
密封陈列盒系列

产品编号 (Item No.) MY-0501/02/03/04	 <p>透明盖</p> <p>φ250</p> <p>容量 (Capacity) 4L/6L/8L/13L</p> <p>材质 (The material) PC/PET</p> <p>φ250*100 φ250*150 φ250*200 φ250*300</p>
<p>容纳食材: 彩虹糖≈11kg、鱼胶≈4kg、人参≈9kg、冬虫夏草≈24kg Food ref: Skittles 11kg, Isinglass 4kg, Ginseng 9kg, Cordyceps 24kg</p>	



产品编号 (Item No.) MY-0701/02/03	 <p>透明盖</p> <p>φ300</p> <p>容量 (Capacity) 9L/12L/18L</p> <p>材质 (The material) PC</p> <p>φ300*150 φ300*200 φ300*300</p>
<p>容纳食材: 人参≈13kg、鱼胶≈6kg、冬虫夏草≈32kg、鹿茸≈30kg Food ref: Ginseng 13kg, Isinglass 6kg, Cordyceps 32kg, Antler 30kg</p>	



M **M SERIES**
FOOD BINS
密封陈列盒系列

<p>产品编号 (Item No.)</p> <p>MF-10/11/12</p>	
<p>产品尺寸 (Product size)</p> <p>256*287*200 254*252*200 243*340*200</p>	
<p>容量 (Capacity)</p> <p>10L/8L/8L</p>	
<p>材质 (The material)</p> <p>PC</p>	
<p>容纳食材: 开心果 ≈ 7kg、葵花籽 ≈ 15kg、彩虹糖 ≈ 9kg、花生 ≈ 15kg Food ref: Pistachios 7kg, Sunflower Seeds 15kg, Skittles 9kg Peanuts 15 kg</p>	



S SERIES FOOD BINS

散称陈列盒系列

食品级材料，经典款零食盒
搭配货柜不占空间

Food grade raw material, classic
display and save spaces.

*部分适用食品展示

Features:

各类独立包装零食*

Prepackaged food





SUPERMARKET ESSENTIAL



S SERIES FOOD BINS 配套陈列系列

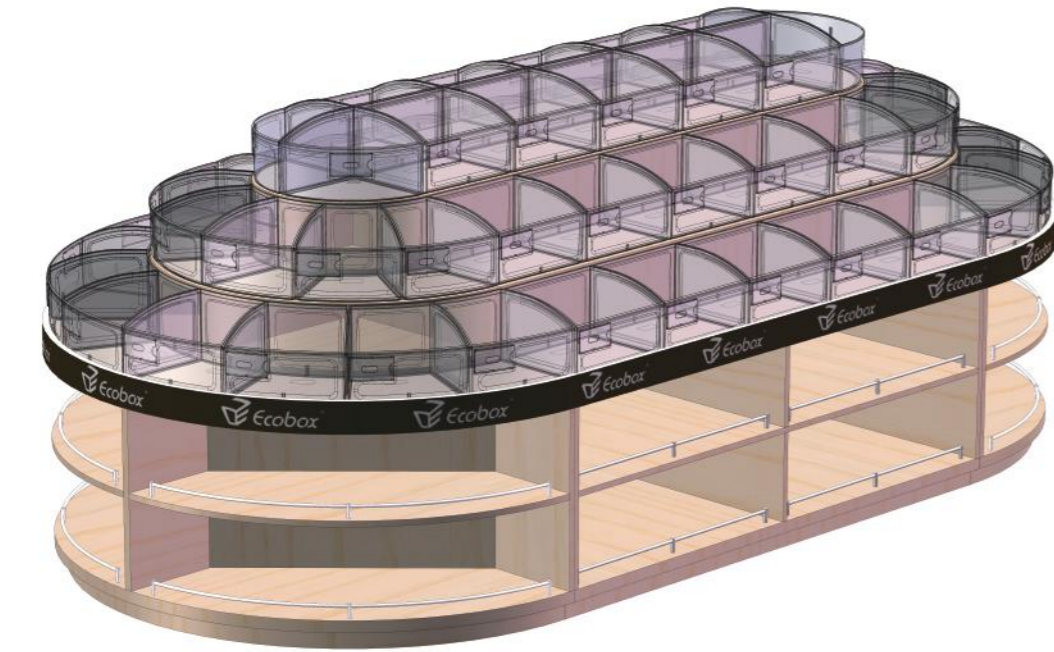

板色可选
(Color available)



红木纹



梨木纹



胡桃木纹



拉美橡木



柜子组合方式

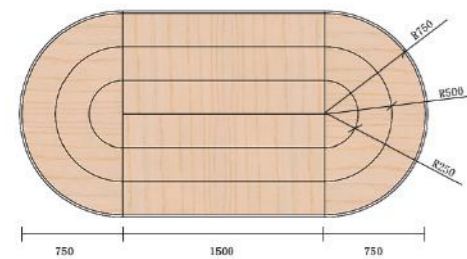

俯视图
(Top View)

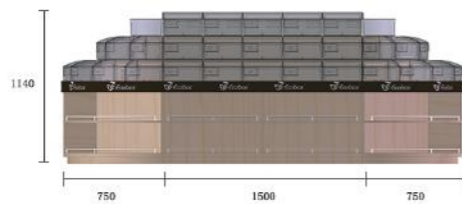

正面视图
(Front View)

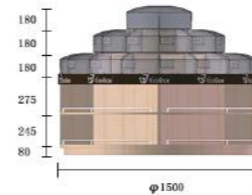

端面视图
(End View)

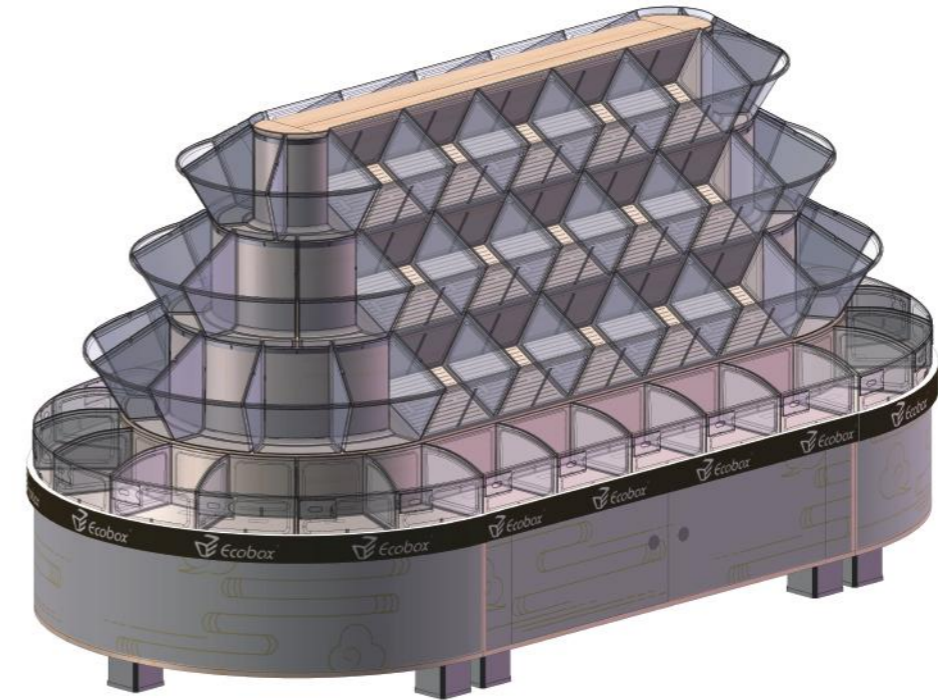

板色可选
(Color available)



红木纹



梨木纹



胡桃木纹



拉美橡木



柜子组合方式

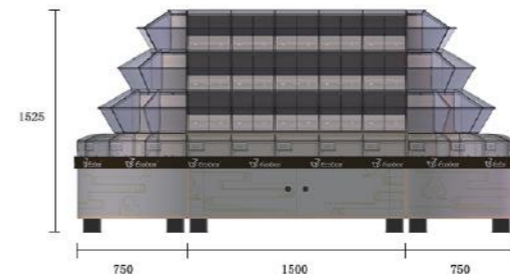

正面视图
(Front View)

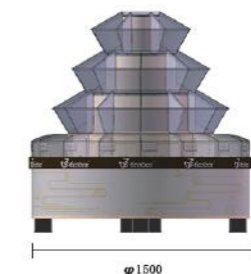

端面视图
(End View)

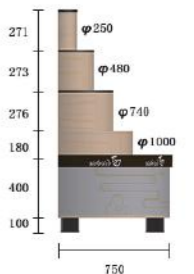

端柜侧视图
(side view)

陈列名称: 直径1.5米三层中岛 (1.5M OD ROUND THREE LAYER ISLAND DISPLAY SHELF)					
序号 (Item)	名称 (Name)	规格 (Spec) 单位(spec):m			数量 (Qty)
1	直柜 (Shelf)	0.9×0.75	1.2×0.75	1.5×0.75	2 4 6
2	端头半圆柜 (Round Shelf)	1.5×0.75			2
配套食品盒 (Related Food Bins)					
	配套 P/N	数量 (Qty)	配套 P/N	数量 (Qty)	
3	SL-01	30	SL-09	30	
4	SL-02	16	SL-10	16	
5	SL-03	12	SL-11	12	
6	SL-04	2	SL-04	2	



陈列名称: 直径1.5米四层中岛 (1.5M OD ROUND FOUR LAYER ISLAND DISPLAY SHELF)					
序号 (Item)	名称 (Name)	规格 (Spec) 单位(spec):m			数量 (Qty)
1	直柜 (Shelf)	0.9×0.75	1.2×0.75	1.5×0.75	2 4 6
2	端头半圆柜 (Round Shelf)	1.5×0.75			2
配套食品盒 (Related Food Bins)					
	配套 P/N	数量 (Qty)	配套 P/N	数量 (Qty)	
3	SL-05	30	SL-05	30	
4	SL-01	10	SL-09	10	
5	SL-02	16	SL-10	16	
6	SL-06	12	SL-06	12	
7	SL-07	8	SL-07	8	
8	SL-08	6	SL-08	6	

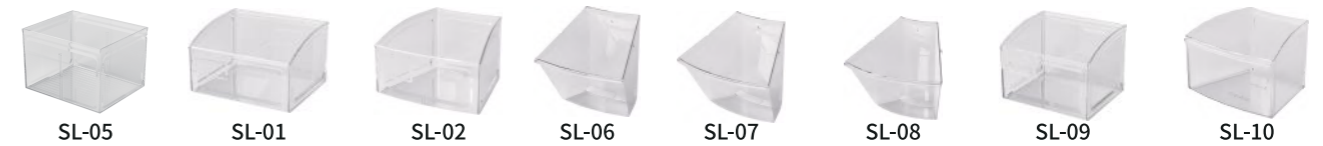

S SERIES FOOD BINS 配套陈列系列

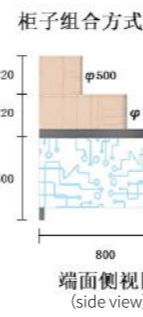
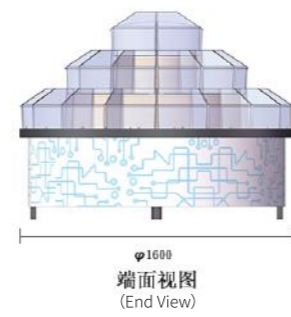
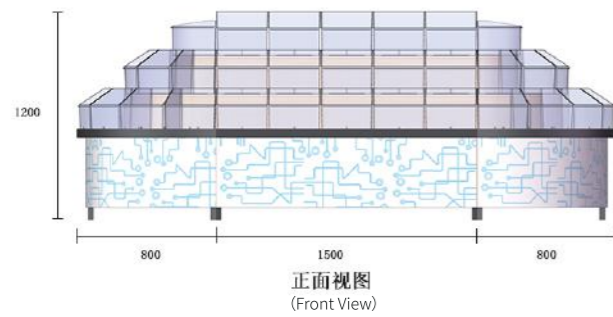
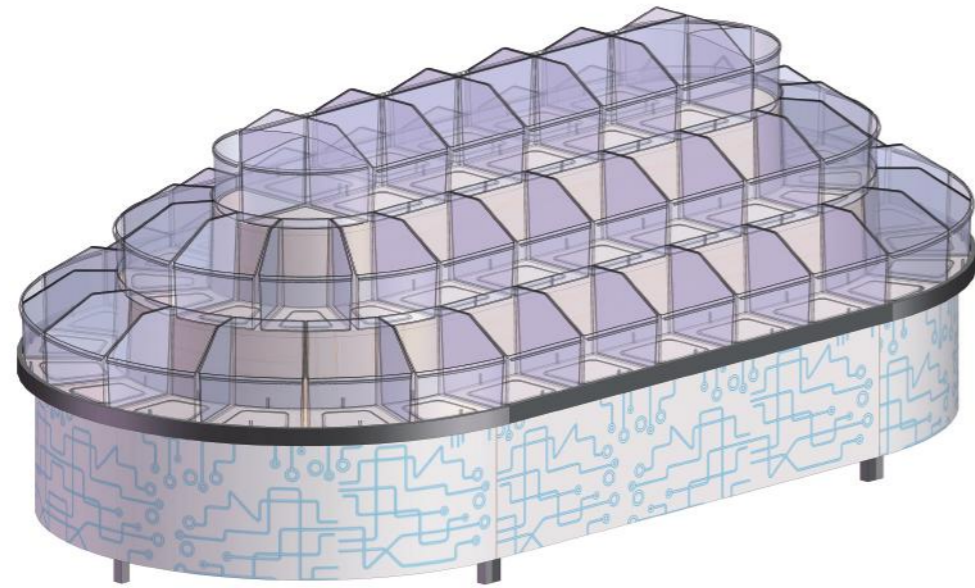

陈列名称: 直径1.6米三层中岛 (1.6M OD ROUND THREE LAYER ISLAND DISPLAY SHELF)					
序号 (Item)	名称 (Name)	规格 (Spec) 单位(spec):m			数量 (Qty)
1	直柜 (Shelf)	0.9×0.8	1.2×0.8	1.5×0.8	2 4 6
2	端头半圆柜 (Round Shelf)	1.6×0.8			2
配套食品盒 (Related Food Bins)					
	配套 P/N				数量 (Qty)
3	ST-05				4
4	SH-06				30
5	SH-07				16
6	SH-08				12

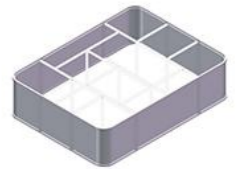
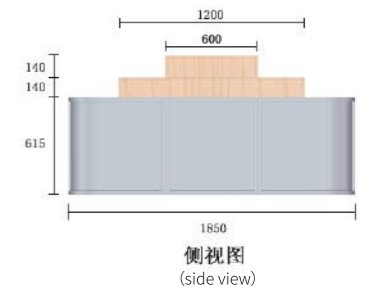
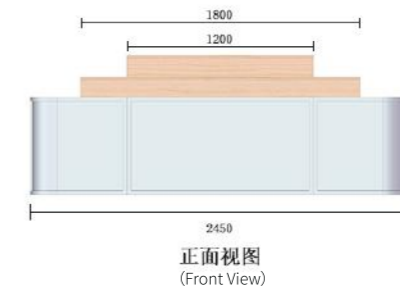
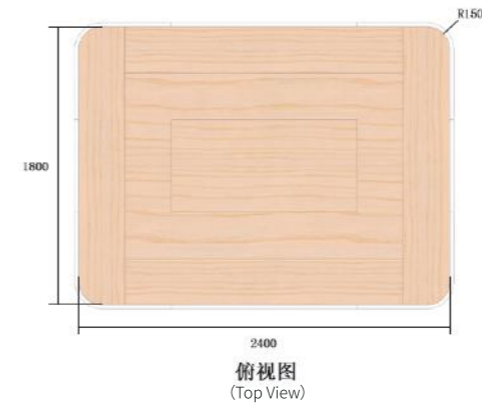
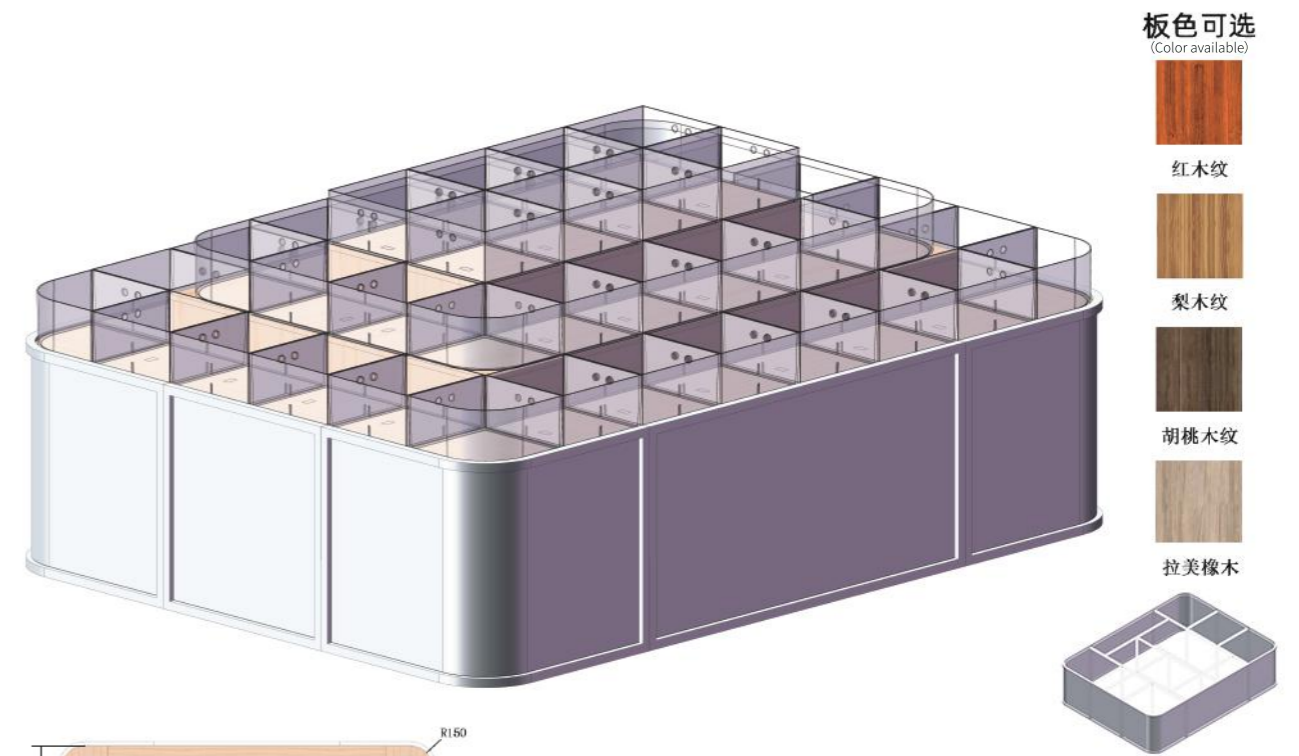

内部支架结构

陈列名称: 1.8×2.4米方形陈列柜 (1.8X2.4M SQUARE DISPLAY SHELF)				
序号 (Item)	名称 (Name)	规格 (Spec) 单位(spec):m		数量 (Qty)
1	方形柜 (Shelf)	1.8×2.4		1
配套食品盒 (Related Food Bins)				
	配套 P/N	数量 (Qty)	配套 P/N	数量 (Qty)
2	SS-09	40	SJ-05	40
3	SS-08	8	SJ-09	8

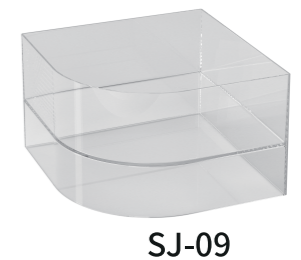
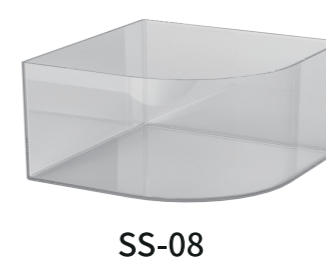

S SERIES FOOD BINS 配套陈列系列

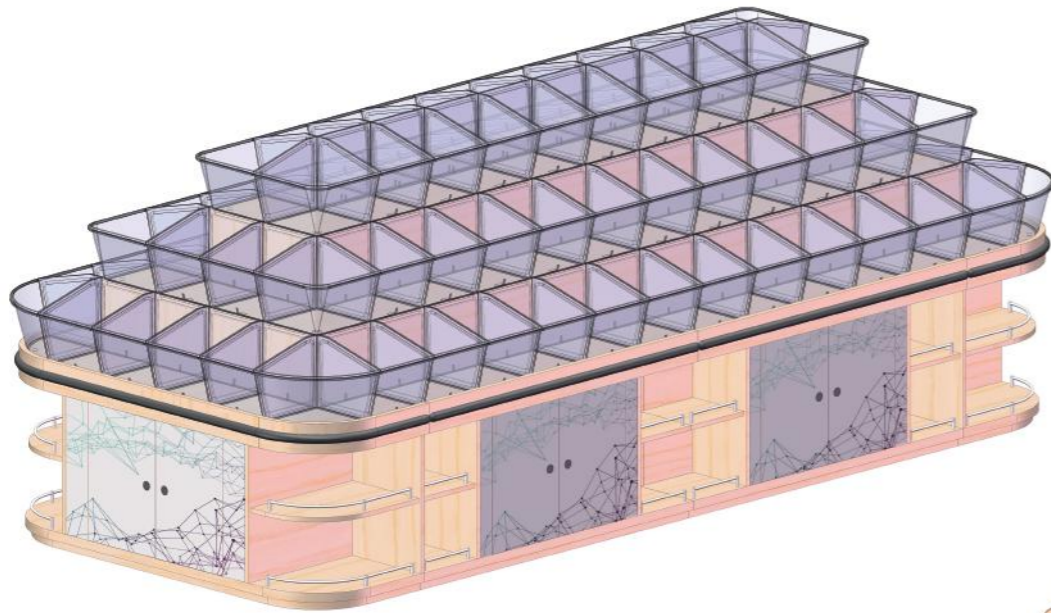

板色可选
(Color available)



红木纹



梨木纹



胡桃木纹



拉美橡木



柜子组合方式

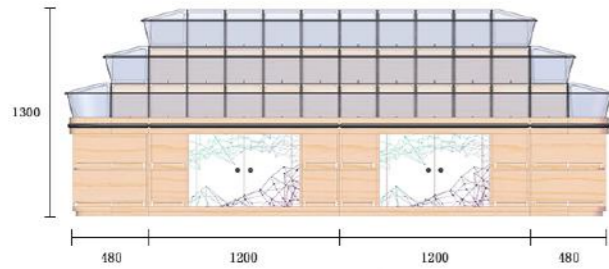

正面视图
(Front View)

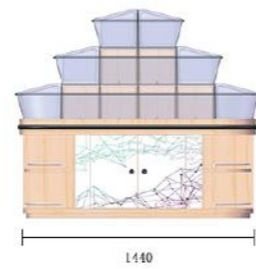

端面视图
(End View)

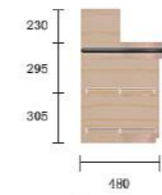

端柜侧视图
(side view)

陈列名称: 1.44×3.4米三层方形中岛 (1.44X3.4 M THREE LAYER SQUARE ISLAND DISPLAY SHELF)				
序号 (Item)	名称 (Name)	规格 (Spec)	数量 (Qty)	
1	直柜 (Shelf)	1.2×0.72	2	4 6
2	端头半圆柜 (Round Shelf)	1.44×0.48	2	
配套食品盒 (Related Food Bins)				
	配套 P/N	数量 (Qty)	配套 P/N	数量 (Qty)
3	SP-01	72	SP-07	72
4	SP-02	4	SP-10	4
5	SP-03	8	SP-09	8
6	SP-04	/	SP-08	/

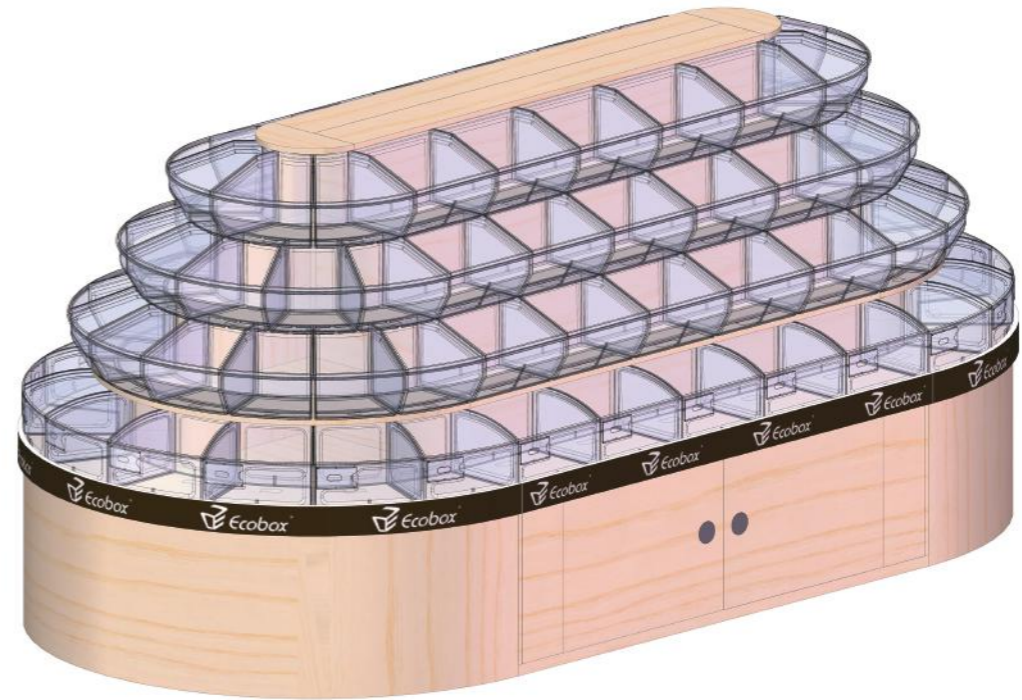

板色可选
(Color available)



红木纹



梨木纹



胡桃木纹



拉美橡木



柜子组合方式

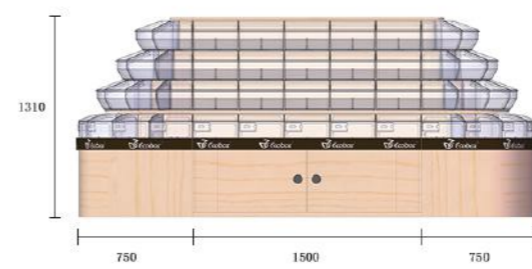

正面视图
(Front View)

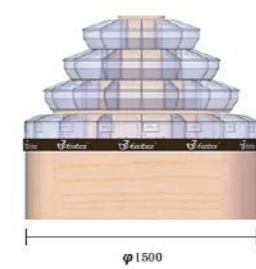

端面视图
(End View)

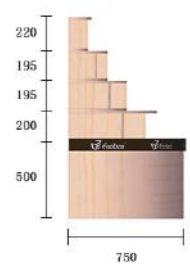

端柜侧视图
(Side View)

陈列名称: 直径1.5米四层中岛 (1.5M OD ROUND FOUR LAYER ISLAND DISPLAY SHELF)				
序号 (Item)	名称 (Name)	规格 (Spec)	数量 (Qty)	
1	直柜 (Shelf)	0.9×0.75 1.2×0.75 1.5×0.75	2	4 6
2	端头半圆柜 (Round Shelf)	1.5×0.75	2	
配套食品盒 (Related Food Bins)				
	配套 P/N	数量 (Qty)	配套 P/N	数量 (Qty)
3	SL-01	10		
4	SL-02	16		
5	SL-13	30		
6	SL-14	16		
7	SL-15	12		
8	SL-16	8		



S **S SERIES**
FOOD BINS
配套陈列系列

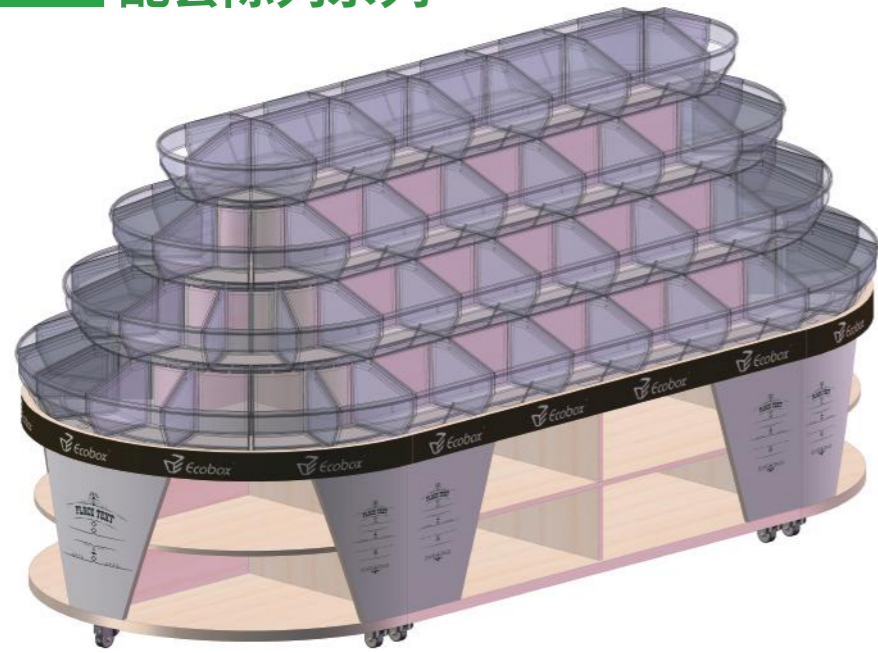

板色可选
(Color available)



红木纹



梨木纹



胡桃木纹



拉美橡木

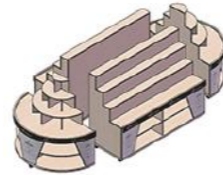

柜子组合方式



端面侧视图
(Side view)

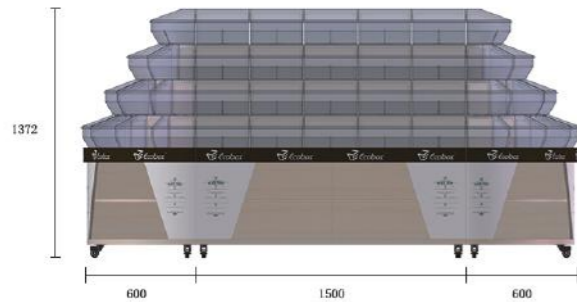

正面视图
(Front View)



端面视图
(End View)

陈列名称: 直径1.2×2.7米四层中岛 (1.2X2.7M OD FOUR LAYER ISLAND DISPLAY SHELF)

序号 (Item)	名称 (Name)	规格 (Spec) 单位(spec):m	数量 (Qty)
1	直柜 (Shelf)	0.9×0.6 1.2×0.6 1.5×0.6	2 4 6
2	端头半圆柜 (Round Shelf)	1.5×0.6	2
配套食品盒 (Related Food Bins)			
	配套 P/N		数量 (Qty)
3	SL-13		40
4	SL-14		16
5	SL-15		12
6	SL-16		8
7	SL-17		4



产品编号 (Item No.) SG-02/03/04	
产品尺寸 (Product size) 220*270*178 300*270*178 440*270*178	
材质 (The material) PP/PET	

产品编号 (Item No.) SS-01/02	
产品尺寸 (Product size) 268*294*178	
产品尺寸 (Product size) 268*294*178	
材质 (The material) PP/PET	

TECHNICAL RESOURCES | 技术资源

TECHNICAL RESOURCES | 技术资源



FACTORY EQUIPMENT | 生产设备

力求完美用尽可能多的资源，让每个人尽最大的努力发挥作用。
努力完美的达到预定目标，质量是市场竞争的基础不管是在国内市场
还是在海外市场，只有不断的改进产品质量，才能在市场竞争中胜出。
Quality is the basis of competition, we can only win from keep improvement of quality.



FACTORY 生产设备 | EQUIPMENT

